



Cambridge IGCSE™

CANDIDATE
NAME

CENTRE
NUMBER

--	--	--	--	--

CANDIDATE
NUMBER

--	--	--	--

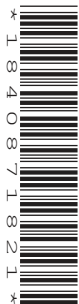

PHYSICS

0625/31

Paper 3 Theory (Core)

May/June 2020

1 hour 15 minutes

You must answer on the question paper.

No additional materials are needed.

INSTRUCTIONS

- Answer **all** questions.
- Use a black or dark blue pen. You may use an HB pencil for any diagrams or graphs.
- Write your name, centre number and candidate number in the boxes at the top of the page.
- Write your answer to each question in the space provided.
- Do **not** use an erasable pen or correction fluid.
- Do **not** write on any bar codes.
- You may use a calculator.
- You should show all your working and use appropriate units.
- Take the weight of 1.0 kg to be 10 N (acceleration of free fall = 10 m/s^2).

INFORMATION

- The total mark for this paper is 80.
- The number of marks for each question or part question is shown in brackets [].

This document has **16** pages. Blank pages are indicated.

- 1 Fig. 1.1 shows a coil of wire.

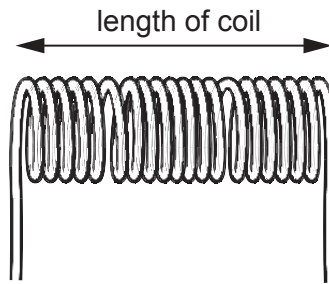

Fig. 1.1 (not to scale)

- (a) A student measures the length of the coil using a ruler. His measurement is 3.8 cm.

There are 20 turns of wire in the coil. The student uses his measurement to calculate the average thickness of the wire.

- (i) Show that the average thickness of the wire is about 0.2 cm.

average thickness of wire = cm [2]

- (ii) The student's measurement of 3.8 cm is inaccurate.

Suggest **one** reason why the measurement is inaccurate.

.....
 [1]

- (b) The volume of the wire in the coil is 16.6 cm^3 and its mass is 148 g.

Calculate the density of the metal used for the wire in the coil.

density = g/cm^3 [3]

(c) The student has a measuring cylinder and a beaker of water, as shown in Fig. 1.2.

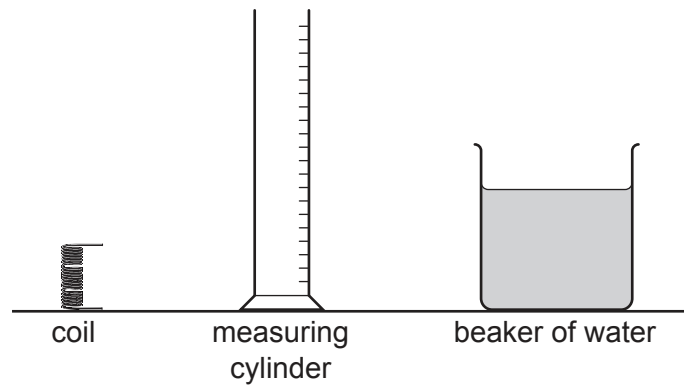

Fig. 1.2

Describe how the student can determine the volume of the coil by using the equipment shown in Fig. 1.2.

.....

.....

.....

.....

.....

.....

..... [4]

[Total: 10]

- 2 (a) A student stretches a spring by adding different loads to it. She measures the length of the spring for each load. She plots a graph of the results.

Fig. 2.1 shows the graph of her results.

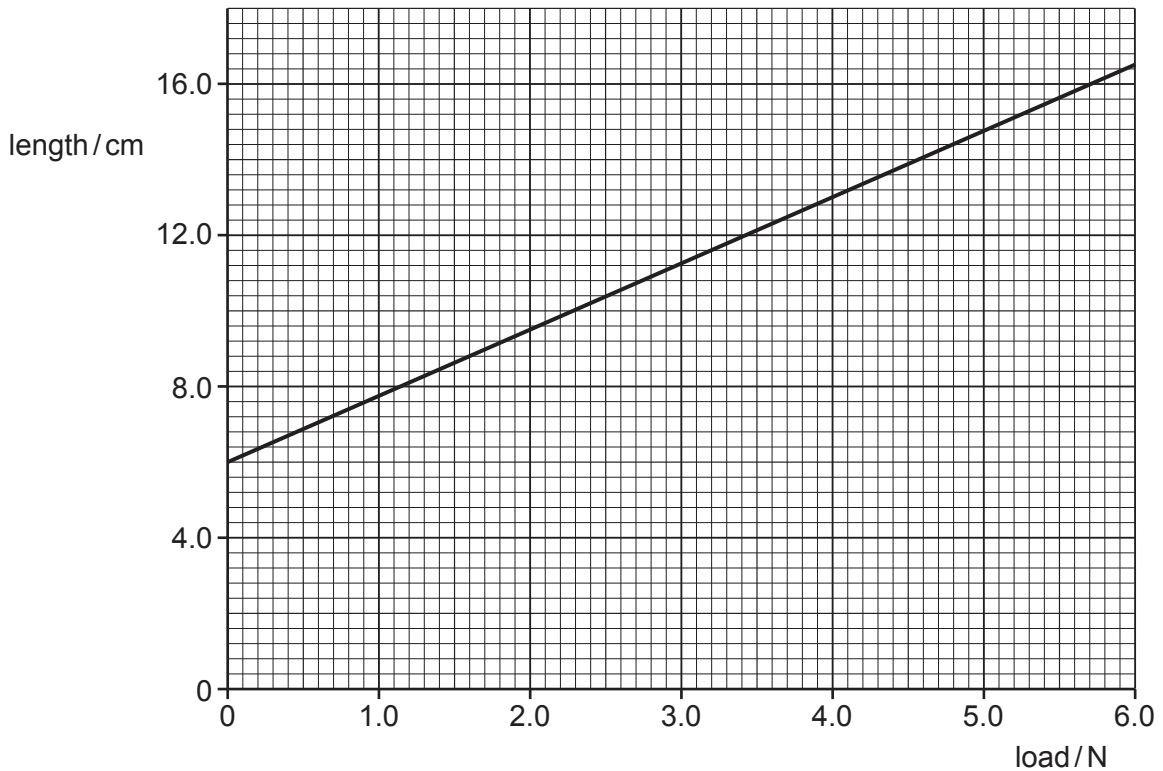

Fig. 2.1

Use the graph to determine:

- (i) the length of the spring without a load

length = cm [1]

- (ii) the length of the spring with a load of 4.0 N

length = cm [1]

- (iii) the extension due to a 4.0 N load.

extension = cm [1]

- (b) Complete the sentence about effects of forces. Choose words from the box.

colour	friction	pressure	shape	size	speed
--------	----------	----------	-------	------	-------

Stretching a spring with a load is an example of how a force can change the

..... and the of an object.

[2]

[Total: 5]

- 3 Some gas molecules are in a box at room temperature. Fig. 3.1 shows the position of some of the molecules and the direction of movement of each molecule.

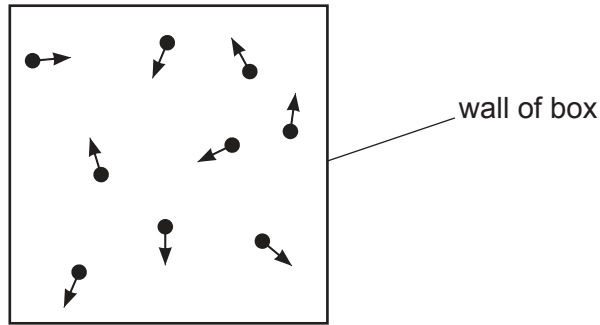

Fig. 3.1

- (a) (i) Describe the movement of the gas molecules.

.....

 [2]

- (ii) Describe how the molecules exert a pressure on the walls of the box.

.....

 [2]

- (b) The gas in Fig. 3.1 is cooled. The gas turns into a liquid then into a solid.

State how the average separation of molecules in the gas is different from the average separation of molecules in the solid.

.....
 [1]

[Total: 5]

4 (a) During part of a race, a skier travels a distance of 200 m in a time of 6.4 s.

Calculate the average speed of the skier.

average speed = m/s [3]

(b) Fig. 4.1 shows a speed–time graph for the skier in another part of the race.

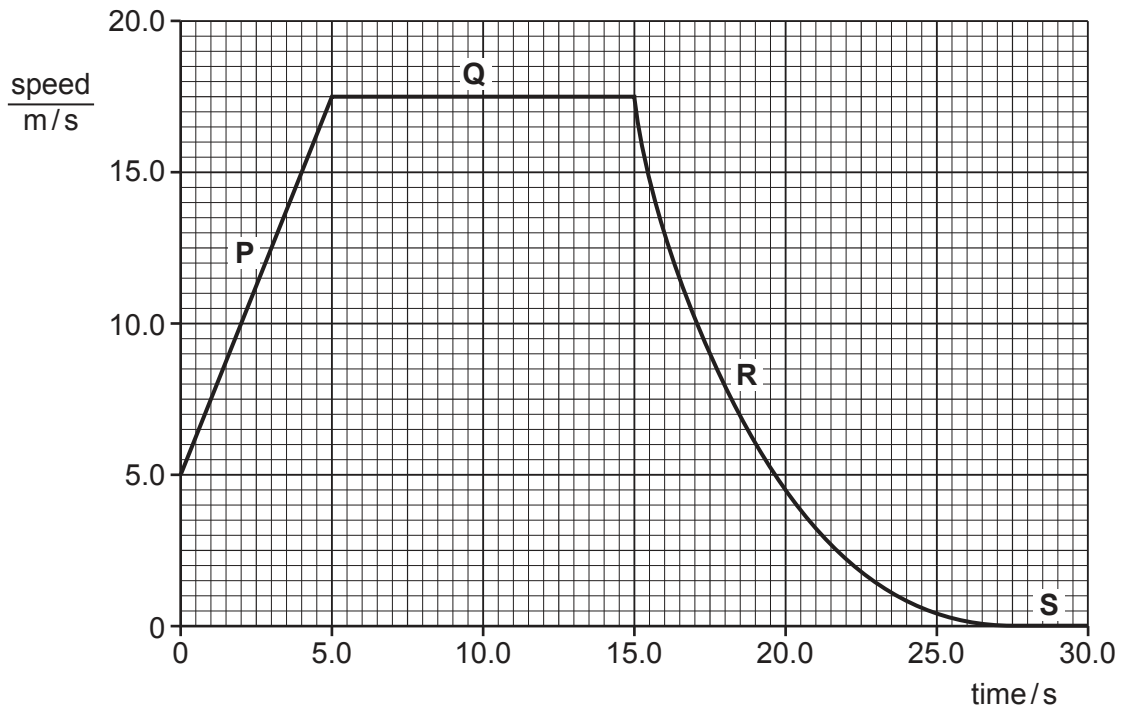

Fig. 4.1

Describe the motion of the skier at each point **P**, **Q**, **R** and **S** on the graph.

- P**
 - Q**
 - R**
 - S**
- [4]

(c) Skis are strapped to a skier’s feet and are longer and wider than the skier’s feet.

Explain how the skis prevent the skier from sinking into soft snow.

.....

.....

..... [2]

[Total: 9]

- 5 A metre rule is balanced on a pivot by three vertical forces, as shown in Fig. 5.1.

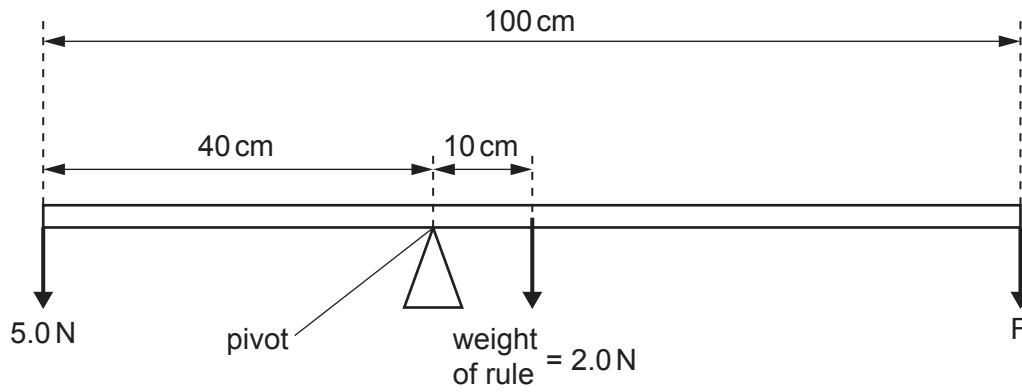

Fig. 5.1 (not to scale)

- (a) Show that the moment of the 5.0 N force about the pivot is 200 N cm.

[2]

- (b) Calculate the size of force F.

F = N [4]

[Total: 6]

6 Fig. 6.1 shows a liquid-in-glass thermometer.

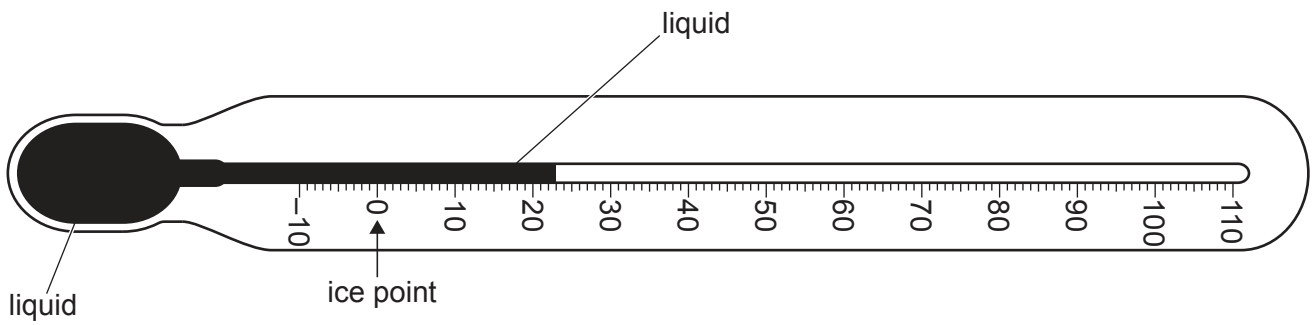

Fig. 6.1

(a) (i) This thermometer is used for measuring temperatures in science experiments.

State the unit for measuring temperature.

..... [1]

(ii) On Fig. 6.1, an arrow points to the temperature reading when the thermometer is placed in pure melting ice. This is labelled **ice point**.

On Fig. 6.1, draw an arrow pointing to the temperature reading when the thermometer is at the upper fixed point. Label this arrow **steam point**. [1]

(b) A liquid-in-glass thermometer uses the property of expansion of a liquid to measure temperature.

State **one** other application or consequence of thermal expansion.

.....
 [1]

(c) A student is testing how different surfaces absorb radiant heat.

The student puts two metal plates in holders and places them on either side of a radiant heater as shown in Fig. 6.2. One plate has a shiny metal side facing towards the heater and the other plate has a dull black side facing towards the heater.

A metal disc is attached to each plate using wax.

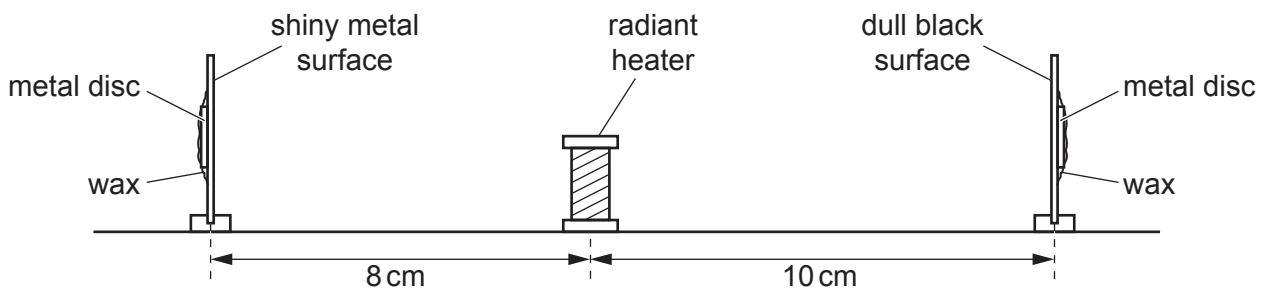

Fig. 6.2

- (i) The student turns on the radiant heater and starts a stop-clock. The wax on the plate with a dull black side melts and the metal disc falls off the plate 53 seconds after the stop-clock is started.

The metal disc on the plate with a shiny metal side remains attached for another 32 seconds after the metal disc on the first plate falls.

Explain why the metal disc on the plate with a dull black side falls before the metal disc on the plate with a shiny metal side.

.....
.....
.....
.....
..... [2]

- (ii) Another student observes the experiment shown in Fig. 6.2 and says that the comparison of the two plates is not fair.

Suggest why the experiment is **not** fair.

.....
..... [2]

[Total: 7]

7 (a) Fig. 7.1 shows a ray of light striking a plane mirror at point P.

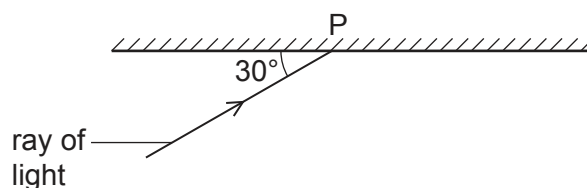

Fig. 7.1 (not to scale)

(i) Determine the value of the angle of incidence for the ray of light at point P.

angle of incidence = ° [1]

(ii) On Fig. 7.1,

- draw a normal at point P
- draw the ray reflected at point P
- determine the angle of reflection at point P.

angle of reflection = ° [3]

(b) Fig. 7.2 shows an object OB positioned 20 cm from a thin converging lens. Both principal foci of the lens are labelled F.

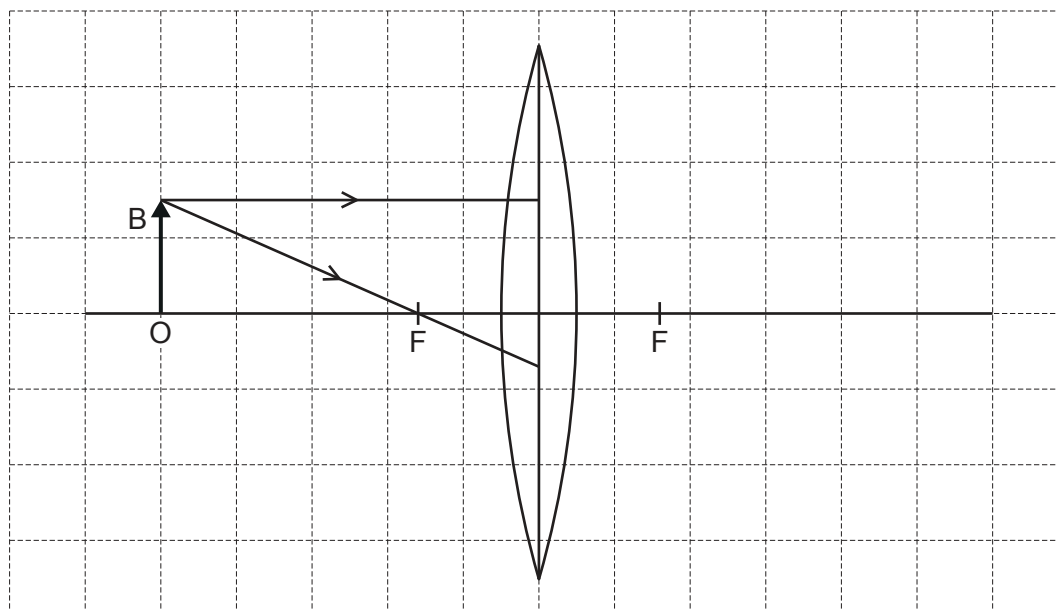

Fig. 7.2

Two rays from the tip B of the object are incident on the lens, as shown in Fig. 7.2.

On Fig. 7.2, continue the paths of these two rays to show the position of the image of OB formed by the lens. Draw an arrow to show the size, position and orientation of the image of OB. [4]

[Total: 8]

8 Fig. 8.1 represents the pressure at one instant along part of a sound wave.

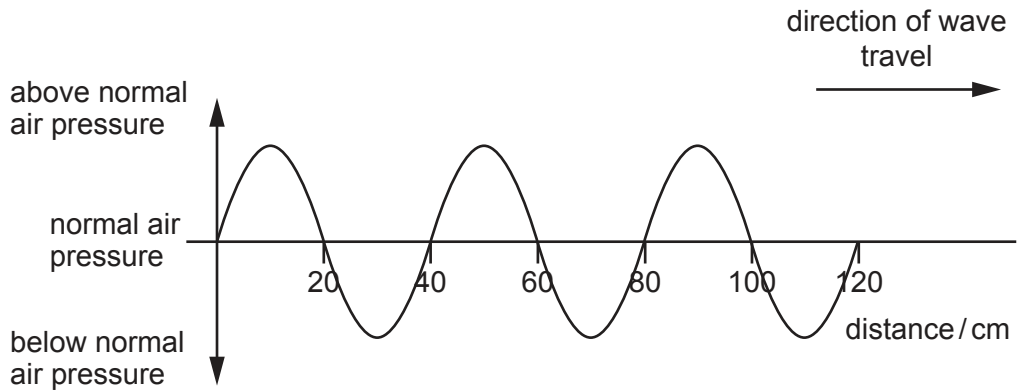

Fig. 8.1

(a) (i) Determine the wavelength of the sound wave.

wavelength of the sound wave = cm [1]

(ii) On Fig. 8.1, draw a wave representing a louder sound of the same wavelength. [1]

(b) State the range of audible frequencies for a healthy human ear. Include the unit.

..... [2]

[Total: 4]

9 (a) Fig. 9.1 shows the magnetic field pattern around a bar magnet.

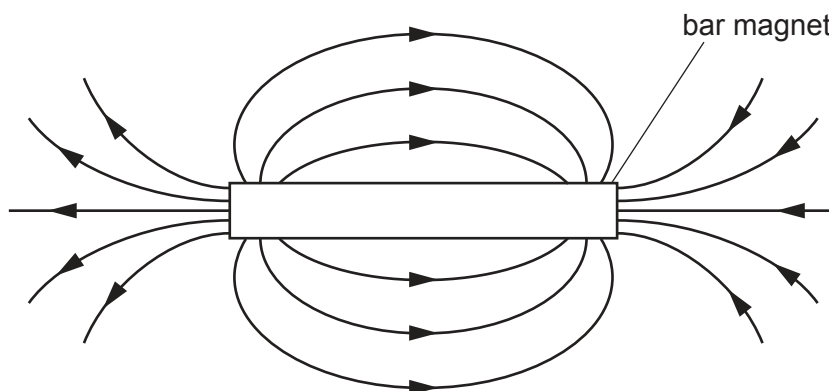

Fig. 9.1

(i) On Fig. 9.1, write the letters N and S to indicate the north and south poles of the magnet. [1]

(ii) Fig. 9.2 shows a soft-iron bar placed close to a permanent magnet.



Fig. 9.2

State and explain what happens to the soft-iron bar. You may draw on Fig. 9.2.

.....

.....

..... [3]

(b) Three balls P, Q and R are electrically charged. The balls are suspended by threads of insulating material. Fig. 9.3 shows the arrangement.

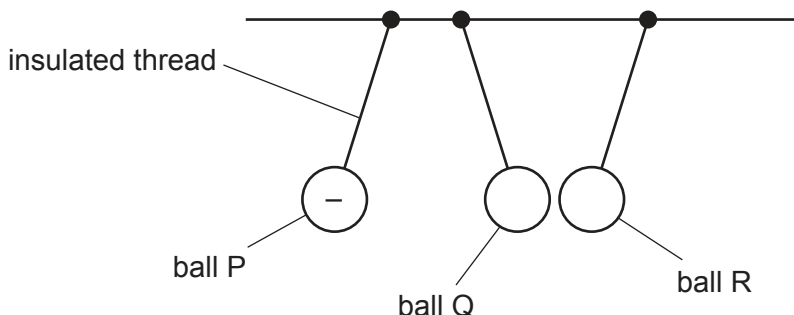

Fig. 9.3

Ball P is negatively charged.

(i) State the charge on ball Q and the charge on ball R.

ball Q

ball R

[2]

(ii) Explain your answer for part (i) for the charge on ball Q.

.....

.....

..... [2]

[Total: 8]

10 (a) A student investigates the electrical resistance of some components.

Fig. 10.1 shows an incomplete diagram of the circuit used by the student.

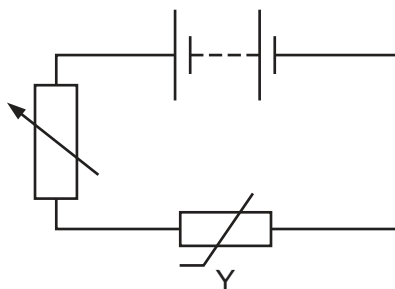

Fig. 10.1

- (i) State the term used for component Y. [1]
- (ii) The student uses the circuit to measure the resistance of component Y.

Complete the diagram in Fig. 10.1 by adding electrical symbols to show an ammeter and a voltmeter correctly connected to determine the resistance of component Y. [3]

(b) Fig. 10.2 shows two resistors A and B.

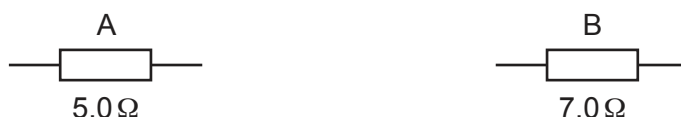

Fig. 10.2

- (i) Resistor A and resistor B are connected in series.
State the value of their combined resistance.
..... Ω [1]

- (ii) Resistor A and resistor B are connected in parallel.
Compare the combined resistance when in parallel with the resistance of resistor A alone.
..... [1]

[Total: 6]

11 A teacher uses a power supply in a metal case. The circuit for the power supply includes a fuse.

(a) (i) Draw the electrical symbol for a fuse. [1]

(ii) The metal case of the power supply is earthed. A fault occurs and a live wire touches the metal case.

Explain how earthing the metal case protects the teacher.

.....
.....
.....
..... [3]

(b) The power supply circuit includes a transformer. Its input voltage is 240V. There are 960 turns on the input coil and 64 turns on the output coil.

Calculate the output voltage of the transformer.

output voltage = V [3]

[Total: 7]

12 Radioactive sources emit α -(alpha), β -(beta) and γ -(gamma) radiations.

(a) State which of these types of radiation can pass through paper.

..... [1]

(b) Barium-137 is a radioactive isotope. The nuclide notation for barium-137 is

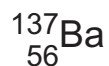

Determine the number of neutrons in a nucleus of barium-137.

number of neutrons = [1]

(c) An isotope of barium-137 has a half-life of 3 minutes.

A radioactive source contains 36 mg of this isotope.

Calculate the mass of the isotope that remains in the source after 9 minutes.

mass of the isotope remaining = mg [3]

[Total: 5]

Permission to reproduce items where third-party owned material protected by copyright is included has been sought and cleared where possible. Every reasonable effort has been made by the publisher (UCLES) to trace copyright holders, but if any items requiring clearance have unwittingly been included, the publisher will be pleased to make amends at the earliest possible opportunity.

To avoid the issue of disclosure of answer-related information to candidates, all copyright acknowledgements are reproduced online in the Cambridge Assessment International Education Copyright Acknowledgements Booklet. This is produced for each series of examinations and is freely available to download at www.cambridgeinternational.org after the live examination series.

Cambridge Assessment International Education is part of the Cambridge Assessment Group. Cambridge Assessment is the brand name of the University of Cambridge Local Examinations Syndicate (UCLES), which itself is a department of the University of Cambridge.